



# DOP-107EV DOP-107CV

## Instruction Sheet

### (1) General precautions

Thank you for purchasing this product. This instruction sheet provides information about the DOP-100 series HMI. Before using this product, please read through this instruction sheet carefully to ensure the correct use of the product. Please keep this sheet handy for quick reference whenever needed. Before finishing reading this sheet, please follow the instructions below:

- Install the product in an indoor location, which is free of vapor, corrosive and inflammable gas and liquids.
- Please refer to the wiring diagram when connecting the wires.
- Ensure your HMI is correctly grounded. The grounding method must comply with the national electrical standard (please refer to NFPA 70: National Electrical Code, 2005 Ed.).
- Do not disassemble the HMI or change the wiring when power is on.
- Do not touch the power supply when power is on, or it may cause electric shock.
- When the HMI displays a low power notification and requires a battery change, please contact your local distributor or Delta Customer Service Center for the replacement. Do not change the batteries by yourself.
- This product can be used with other industrial automation equipment. Please read through this sheet carefully and install the product according to the instructions to avoid danger.
- Cleaning method: please use a dry cloth to clean the product.
- This product must be used at an altitude below 2,000 m.
- If the equipment is used in a manner not specified by the manufacturer, the protection provided by the equipment may be impaired.
- For repair and maintenance, please contact Delta Electronics, Inc. Address: No.18, Xinglong Rd., Taoyuan City, Taiwan. TEL: +886-3-3626301.

If you have any inquiry during operation, please contact our local distributors or Delta sales representatives. The content of this instruction sheet may be revised without prior notice. Please consult our distributors or download the latest version at Delta's website (<http://www.delta.com.tw/ia>).

### (2) Communication port pin assignment

#### DOP-107CV / DOP-107EV COM1

COM Port	Pin	MODE1
		RS-232
	1	-
	2	RXD
	3	TXD
	4	-
	5	GND
	6	-
	7	RTS
	8	CTS
	9	-

#### DOP-107CV / DOP-107EV COM2

COM Port	Pin	MODE1		MODE2		MODE3	
		COM2	COM3	COM2	COM3	COM2	COM3
		RS-232	RS-485	RS-485	RS-485	RS-232	RS-422
	1	-	-	D+	-	-	TXD+
	2	RXD	-	-	-	RXD	-
	3	TXD	-	-	-	TXD	-
	4	-	D+	-	D+	-	RXD+
	5	GND		GND		GND	
	6	-	-	D-	-	-	TXD-
	7	RTS	-	-	-	RTS	-
	8	CTS	-	-	-	CTS	-
	9	-	D-	-	D-	-	RXD-

Note: mark "-" means connection is not required.

### (3) Description of each part

#### DOP-107CV / DOP-107EV (front view)

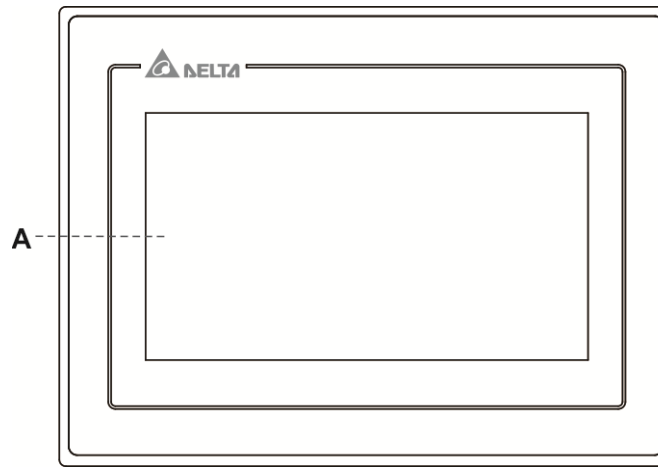

A Operation / display area

#### DOP-107CV / DOP-107EV (rear view)

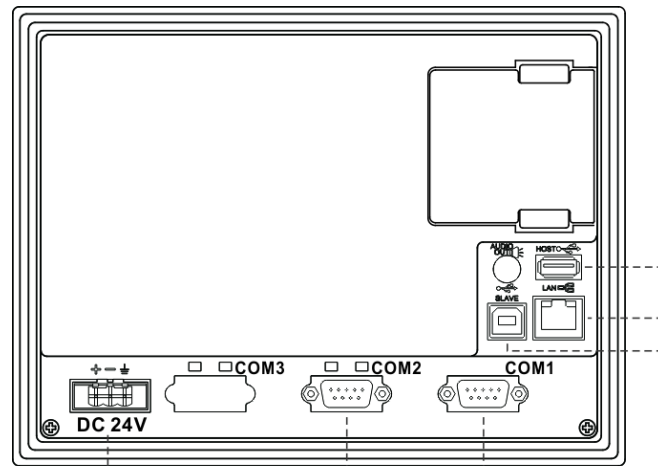

A	Power input terminal (24AWG wire min.)	B	COM2/COM3
C	COM1	D	USB Host
E	Network port (LAN) Only for DOP-107EV	F	USB Slave

### (4) Mounting dimensions

#### DOP-107CV / DOP-107EV

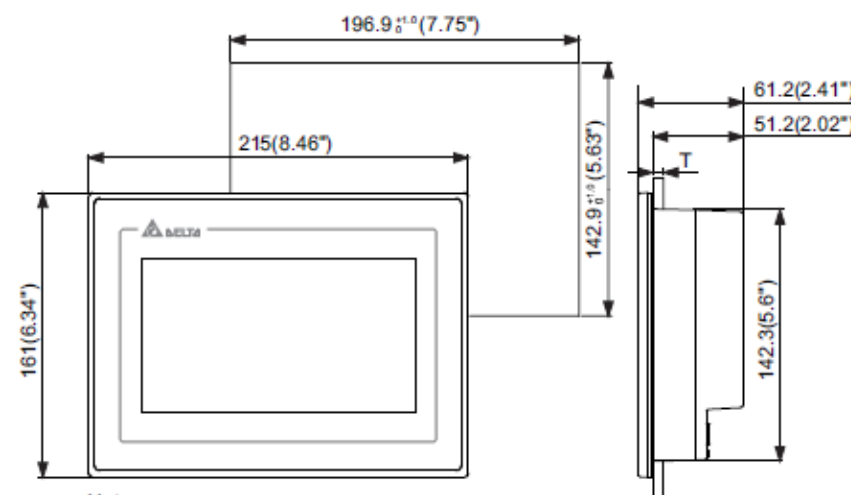

Note:  
T=1.6 mm ~ 6 mm (0.063" ~ 0.24")

Unit: mm (inch)

Operation temperature: 0°C to 50°C (32°F to 122°F)  
Storage temperature: -20°C to 60°C (-4°F to 140°F)

### (5) Installation and wiring

#### Precautions:

- Incorrect installation may result in malfunction.
- To ensure the HMI is well ventilated, make sure there is sufficient space between the HMI and the adjacent objects or walls.
- This product should be used on a case / platform which conforms to enclosure Type 4X standard (for indoor use only).
- The maximum panel thickness for mounting must be no greater than 5 mm.
- Copper conductor only.

#### Installation steps:

Step 1:  
Put the waterproof gasket into the HMI and then insert the HMI into the panel cutout.

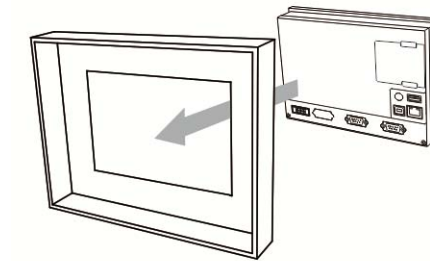

Step 2:  
Place the fasteners into the slots and tighten the screws until reaching the panel cutouts.

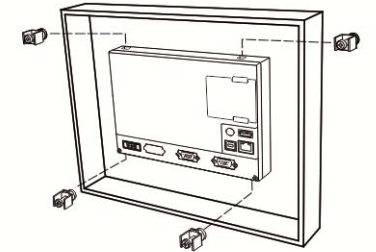

Step 3:  
Tighten the screws with the torque less than 0.5 N-M / 0.7 N-M to avoid damage to the plastic case.  
Torque for DOP-107CV / DOP-107EV:  
6.17 lb-inch (0.7 N-M)

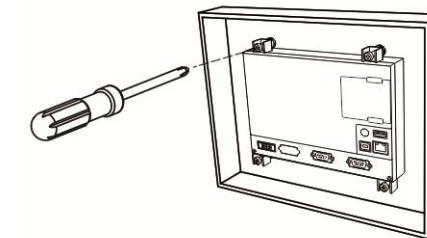

Step 4:  
For heat dissipation, please keep a minimum clearance of 60 mm on the rear of the HMI.

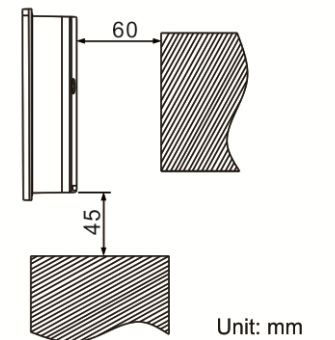

Unit: mm

#### Wiring:

Type	Wire gauge (AWG)	Stripped length	Torque
Solid	24 - 12	7 - 8 mm	5 kg-cm (4.3 lb-in)
Stranded	24 - 12	7 - 8 mm	5 kg-cm (4.3 lb-in)



Please refer to the following diagram when wiring the power connector. The temperature rating of the cable must be greater than 75°C (167°F).

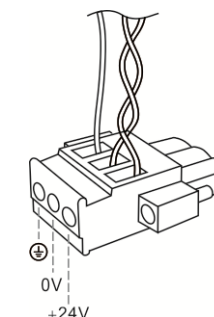

(6) Hardware specifications

Model		DOP-107CV	DOP-107EV
Display	Panel type	7" TFT LCD (65535 colors)	
	Resolution	800 x 480 pixels	
	Backlight	LED Back Light (half-life under room temperature 25°C > 20,000 hours) <sup>1</sup>	
	Display range	154.08 x 85.92 mm	
	Brightness	400 cd / m <sup>2</sup> (Typ.)	
CPU		ARM Cortex-A8 (800 MHz)	
Flash ROM		256 Mbytes	
RAM		256 Mbytes	
Touchscreen		4-wire resistive touchscreen > 10,000,000 operated	
Buzzer		Multi-tone Frequency (2K – 4K Hz) / 80 dB	
Network interface		N/A	1 Port, 10 / 100 Mbps auto detection (built-in isolated circuit) <sup>2</sup>
USB		1 USB Slave Ver. 2.0; 1 USB Host Ver. 2.0	
SD		N/A	
Serial communication port	COM1	RS-232 (supporting flow control) <sup>2</sup>	
	COM2	RS-232 (supporting flow control) / RS-485 <sup>2</sup>	
	COM3	RS-422 / RS-485 <sup>2</sup>	
Auxiliary function key		N/A	
Calendar		Built-in	
Cooling method		Natural cooling	
Approvals		CE / UL (please use shielding network cable and magnetic ring with the filter of 300 ohm / 100 MHz)	
Panel waterproof level		IP65 / NEMA4 / UL TYPE 4X (indoor use only)	
Operation voltage <sup>2</sup>		DC +24V (-15% to +15%) (please use an isolated power supply) Supplied by Class 2 or SELV circuit (isolated from MAINS by double insulation)	
Leakage current		500 V <sub>AC</sub> for 1 minute (between DC24V terminal and FG terminal)	
Power consumption <sup>2</sup>		8.5 W (Max) <sup>3</sup>	8.76 W (Max) <sup>3</sup>
Backup battery		3V lithium battery CR2032 × 1	
Backup battery life		About 3 years or more at 25°C (subject to operation temperature and condition)	
Operation temperature		0°C to 50°C (32°F to 122°F)	
Storage temperature		-20°C to +60°C (-4°F to 140°F)	
Operating environment		10% to 90% RH [0°C - 40°C], 10% to 55% RH [41°C - 50°C]; pollution degree: 2	
Vibration resistance		Conforms to IEC61131-2: continuous vibration 5 Hz - 8.3 Hz with amplitude 3.5 mm; 8.3 Hz - 150 Hz with amplitude 1G	
Shock resistance		Conforms to IEC60068-2-27: 11 ms, 15 G Peak, in X, Y, Z directions each for 6 times	
Dimension (W) x (H) x (D) mm		215 x 161 x 61.2	
Mounting dimension (W) x (H) mm		196.9 x 142.9	
Weight		Approx. 970 g	

Note:

1. The half-life of the backlight is defined as the maximum luminance being reduced by 50% when the maximum drive current is supplied to the HMI. The life of LED backlight shown here is estimated at the room temperature of 25°C with ambient humidity.
2. The withstand voltage of the isolated power circuit is 1500V peak for 1 minute.
3. The HMI power consumption is the power consumed when the HMI is not connecting with other peripheral devices. To ensure normal operation of the HMI, the recommended capacity of the power supply is 1.5 to 2 times of the specified power consumption.
4. Isolated power supply is recommended.
5. For the DOPSoft programming software of the DOP-100 series and the user manual, you can download them at <http://www.delta.com.tw/ia>.
6. DOP-100 series can be used with other industrial automation equipment. Please read through this sheet carefully and install the product according to the instructions to avoid danger.